



Evolution
pressure washers

Operating Instructions

Model	
Serial No.	
Engine No.	
Year of Manufacture	



Pressure Washer

Operating Instructions

This manual and any other literature supplied should be read thoroughly before attempting to operate the Power Washer. Pay particular attention to any instructions relating to safety, and the starting, stopping and maintenance of petrol and diesel engines.

**THESE INSTRUCTIONS SHOULD BE KEPT
WITH THE MACHINE AT ALL TIMES.**

This manual has been compiled to give all of the necessary information to operate the Dual Pumps range of Pressure Washers safely and effectively. It is recommended the manual and its accompanying literature be read and understood before attempting to assemble or operate the equipment. Following these simple instructions will ensure operator safety and prolong the life of the power washer.

Our policy is to improve our products continuously and we therefore reserve the right to discontinue or change specifications, models or designs without notice or obligation.

EC DECLARATION OF CONFORMITY

Dual Pumps Ltd
Unit 8, Hudson Road
Saxby Road Ind. Est.
Melton Mowbray
Leicestershire LE13 1BS

Declares that this equipment conforms to the following directives,
2006/42/EC, 2000/14/EC, 2014/30/EU

Tom Herridge
Technical Manager



1. Index

Equipment Variants and Options	section 2
Safety	section 3
Description of Main Features.....	section 4
Installation	section 5
Operation.....	section 6
Maintenance.....	section 7
Storage.....	section 8
Fault Finding.....	section 9
Warranty.....	section 10
Lance Variations.....	appendix 1

2. Equipment Variants and Options

This equipment has been designed and manufactured for the high pressure washing of machinery, buildings etc, using water and detergent. Use only a recommended detergent.

It should not be used for washing electrical equipment, people, animals and surfaces that are loose and easily damaged.

This manual deals with the following variants of pressure washers,

Power input	Petrol and diesel engines. 4bhp – 18bhp
High-pressure Pump	Multi cylinder plunger 10 lpm – 30 lpm 100 bar – 400 bar pump pressure.
Transport frame	Rigid steel frames in either static or wheeled options.

Variants and Options (fig 1)

SPL = Sound Power Level on equipment representative for this type.

GSPL = Guaranteed Sound Power Level for this equipment.

Part No.	Engine	Lpm	Bar	Kg	L x W x H	SPL LwA dB	GSPL LwA dB
GF10150PHR	Petrol GP160	10	150	31	600x450x440	107	111
GF13150PHR	Petrol GP200	13	150	31	600x450x440	106	111
GT10150PHR	Petrol GP160	10	150	36	940x600x890	107	111
GT13150PHR	Petrol GP200	13	150	37	940x600x890	106	111
E1F10135PHR	Petrol GX160	10	135	31.2	600x450x440	107	111
E1T12125DYR	Diesel L48N	12	125	48.5	630x530x810	109	115
E1F12150PHR	Petrol GX160	12	150	31.2	600x400x410	107	111
E1F13150PHR	Petrol GX200	13	150	31.2	600x400x410	107	111
E1T12150PHR	Petrol GX160	12	150	42.8	630x530x810	107	111
E1T13150PHR	Petrol GX200	13	150	43.8	630x530x810	107	111
E1T13200PHR	Petrol GX240	13	200	59	800x640x840	105	111
E1T15275PHR	Petrol GX390	15	275	65.5	800x640x840	107	111
E1T16200PHR	Petrol GX340	16	200	65.5	800x640x840	107	111
E1T20200PHR	Petrol GX390	20	200	65.5	800x640x840	107	111
E1T13170DYR	Diesel L70N	13	170	69	800x640x840	109	115
E2C14150PHR	Petrol GX200	14	150	38.5	600x400x410	106	111
E2T14150PHR	Petrol GX200	14	150	38	630x530x810	106	111
E2T15200PHR	Petrol GX340	15	200	64.5	800x640x840	107	111
E2T15250PHR	Petrol GX390	15	250	64.5	800x640x840	107	111
E2T21200PHR	Petrol GX390	21	200	64.5	800x640x840	107	111
E2T15150DYR	Diesel L70N	15	150	75.5	800x640x840	109	115
E3T15200PHR	Petrol GX340	15	200	77	1100x620x700	107	111
E3T15250PHR	Petrol GX390	15	250	78.5	1100x620x700	107	111
E3T21200PHR	Petrol GX390	21	200	79	1100x620x700	107	111
E3T15400PBE	Petrol V-Twin	15	400	113	1100x620x790	108	108
E3T41200PBE	Petrol V-Twin	41	200	110	1100x620x790	111	111
E3T23250PBE	Petrol V-Twin	23	250	108.5	1100x620x790	108	108
E3T25300PBE	Petrol V-Twin	25	300	110	1100x620x790	111	111
E3T30200PBE	Petrol V-Twin	30	200	108.5	1100x620x790	108	108
E3T15500PBE	Petrol V-Twin	15	500	115	1100x620x790	111	111
E3T15200DYE	Diesel L100N	15	200	108.5	1100x620x720	111	112
E3T20190DYE	Diesel L100N	20	190	109.5	1100x620x720	111	112
E1T12150PHE	Petrol GX160	12	150	40	800x640x840	107	111
E2T14150PHE	Petrol GX200	14	150	42	800x640x840	106	111
E2T15250PHE	Petrol GX390	15	250	66.5	800x640x840	107	111
E2T21200PHE	Petrol GX390	21	200	66.5	800x640x840	107	111
E3T15250PHE	Petrol GX390	15	250	81	1100x620x700	107	111
E3T21200PHE	Petrol GX390	21	200	81	1100x620x700	107	111

3. Safety

Power washers should only be used by fully trained, competent persons. They should not be used by untrained or inexperienced users.

Care should be taken when handling the pressure washers as they have uneven centres of gravity and may topple over when lifted.

3.1 Suitable Persons

Operators should be physically fit and free from the influences of drugs or alcohol.

Prolonged periods of operation are strenuous and operators should be encouraged to take regular breaks. If you have any doubts about your fitness to operate this equipment, seek professional advice before proceeding.

3.2 Protective Clothing

Operators and assistants should wear the following Personal Protective clothing and equipment: -

Waterproof boots with good non-slip soles

Waterproof overalls

Waterproof gloves

*Goggles or full-face protection to at least BS EN166

**Ear Muffs or Ear Plugs to give protection to at least EN352-1. EN352-2

3.3 Use in confined spaces

Diesel and Petrol engines produce fumes and toxic gases, use only in well-ventilated spaces.

To prevent the build up of flammable vapours the charging of petrol and diesel tanks should not be done in confined spaces. Any spillages should be cleaned up and any absorbent material used should be disposed of in a proper manner.

3.4 General Safety

Check all hoses and couplings for tightness and damage, loose connections should be tightened and damaged hoses replaced.

Ensure the workspace is clear and free from obstructions; consideration should be given to the erection of fences or sheeting to prevent injury to others.

High-pressure lances react 'Kick Back' when the operating trigger is pulled. Ensure you have a good firm footing and anticipate this reaction.

Extra care should be taken when working at heights, scaffolding should be in good condition, secure and properly fenced, working from ladders is not recommended.

The high-pressure stream can be dangerous, do not point the stream directly at others or submit them to the fine over-spray.

3.5 Control of Vibration at Work Regulations 2005

This machine in its standard form does not exceed the 2.5 m/s² vibration action value and should not require any daily limitations to its use. Periodic equipment checks and servicing will maintain the characteristics and efficiency of this machine.

Warning:

Any modifications or accessories added or use with this machine may affect the vibration levels. Under the Control of Vibration at Work Regulations it is the employers duty to manage the exposure to vibration and implement training and health surveillance for employees.

Under the Supply of Machinery (Safety) Regulations 1992 (SMSR), you should ensure equipment is in good condition and maintained in accordance with the manufacturers instructions, any modifications or accessories added to this machine should be assessed for safe operation and vibration, then implement appropriate measures.

*** Note: Goggles or Full Face Protection.**

The wearing of eye and face protection in hazardous areas is a requirement under regulation 4 of the personal protective equipment at work regulations 1992.

Regulation 4 requires employers to provide suitable personal protective equipment to employees who may be exposed to risks affecting their health and safety.

Full Face Protection.

High speed flying particles or chemical splashes are rarely aimed directly at the eyes. A full face visor offers the maximum protection in extreme conditions. Full face shields offer a wide area of protection and because of the all round ventilation, remain mist free even in wide temperature swings.

Chemical Splash.

Chemical splashes and vapours can hit you from all sides. It's important that full eye enclosure is selected, e.g. Unvented goggles. Full face shields will also protect the whole face from liquid splashes. Those with chin guards should be selected where there is a danger of splash deflecting up from work surfaces.

Impact.

Impact hazards are caused by fast moving particles from the cleaning operation. The potential impact speed must be assessed before selecting the most appropriate protection. Safety glasses could be dislodged by high velocity impacts, in which case goggles or face shield should be selected.

**** Note: Ear Muffs or Ear Plugs.**

The noise at work regulations require that from February 2006 persons working in noise levels between 80dBA and 85dBA must be provided with suitable hearing protection on request. If noise levels are above 85dBA then hearing protection must be supplied and worn.

4. Description of Main Features (fig 2)

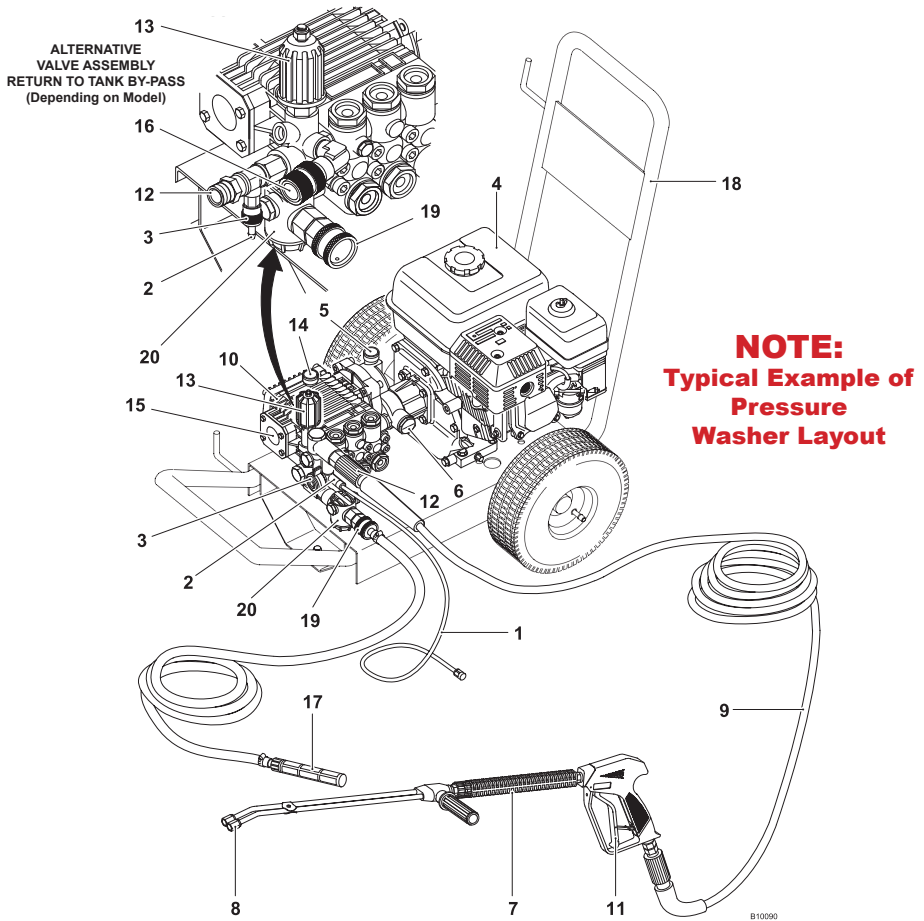

Fig 2 Description of main features

- | | |
|---|---|
| 1. Detergent Hose | 11. Operating Trigger and Safety Catch |
| 2. Detergent Hose Connection | 12. Pressure Hose Connection |
| 3. Detergent Rate Control | 13. Pressure Regulator |
| 4. Drive Engine | 14. Pump Dipstick |
| 5. Gearbox Dipstick (Depending on Model) | 15. Pump Sight Glass |
| 6. Gearbox Sight Glass (Depending on Model) | 16. Return (external return to water supply depending on model) |
| 7. Hand Lance | 17. Suction Filter |
| 8. High/Low Pressure Nozzle | 18. Typical Transport Frame |
| 9. High Pressure Hose | 19. Water Inlet |
| 10. High Pressure Pump | 20. Water Inlet Filter |

5. Installation

- 5.1 From the pump and gearbox (if fitted) remove the 'Red' travel plugs, replacing them with the yellow-topped dipsticks. Check all oil levels, top up if necessary.
- 5.2 Fill engine with oil and fuel, see engine manufacturers handbook for details of oil and fuel types.
- 5.3 Connect the battery leads. (Electric start models only).
- 5.4 Connect the suction hose to the Power Washer (fig 3). Ensure the connection has no air leaks. Air leaks on the suction hose connection will impair the performance of the machine.
- 5.5 Connect the water return line to its connector and place the other end in the water supply container. (Bypass to tank models only) (Fig 2 item 16 & Fig 4).
- 5.6 Submerge the opposite end of the suction hose and its suction filter in a suitable container containing the water supply (fig 4). Ensure the filter is always kept below the water level.
- 5.7 Connect the high-pressure hose to the power washer (fig 5) and to the lance (fig 6). Tighten as appropriate, do not over tighten. Ensure that the trigger safety catch is in the **ON position** whilst making these connections.

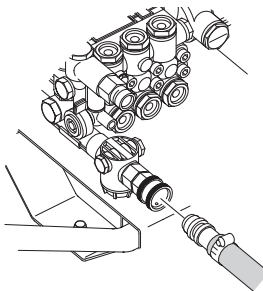

Fig 3

810091

Fig 3. Connect the suction hose.

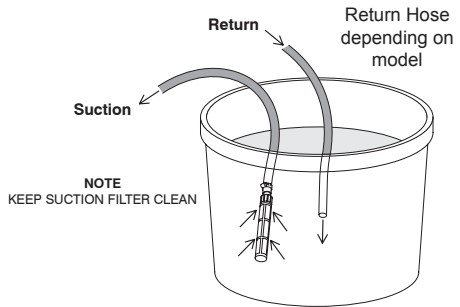

Fig 4. Submerge the suction hose.

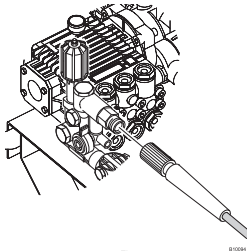

Fig 5

810091

Fig 5. Connect the High-Pressure Hose to the Power Washer.

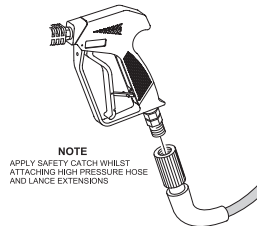

Fig 6

810091

Fig 6. Connect the High-Pressure Hose to the Lance.

6. Operation

6.1 **Start engine** *(Note: Depress the lance trigger to release water pressure before starting the engine).*

Refer to accompanying booklet relating to the type of engine fitted.

6.2 **Using High Pressure Lance** *(Note: See Appendix 1 for lance type and operation)*

Release the lance safety catch, which is located behind the trigger.

6.2.2 Point the lance downwards and towards the object being cleaned.

6.2.3 Squeeze the trigger to start the high-pressure jet, proceed to wash the object. Adjust the working pressure by turning the pressure regulator knob + or - to suit the application (fig 2, item 13). Never direct the high-pressure stream at the engine or pump as this could cause irreparable damage.

WARNING: - High-pressure lances react 'Kick Back' when the operating trigger is pulled. Ensure you have a good firm footing and anticipate this reaction.

6.2.4 Release the trigger to stop the high-pressure jet.

6.3 **Washing using detergent**

Attach the detergent induction pipe to the power washer, (fig 2, item 1) placing the opposite filter end into the detergent container. Select the low pressure setting on the lance, (see appendix 1 for details of your lance) and spray the water/detergent mixture onto the object being cleaned. Leave the detergent for the period recommended by the chemical manufacturer allowing it time to work, washing off with clean water. The volume of detergent used can be controlled by means of the regulator on the suction valve (see fig 2. item 3).

6.4 **Switching Off**

Release trigger.

Stop drive engine, (refer to additional literature / handbook supplied, relating to the type of engine fitted, remembering to switch off ignition after use to prevent draining the battery, electric start models only).

Depress the high-pressure lance's trigger to release the pressure in the high-pressure hose.

Disconnect water supply.

WARNING: Do not let the pump idle in By-Pass for lengthy periods, if you intend to break from work for more than 5 minutes, switch the machine off. Should the machine run for longer period, the temperature of the recirculating water will increase rapidly and could risk damaging the pump seals. (Models with internal by-pass only). Running power washers should never be left unattended.

7. Maintenance

Activity	Each/ First Use	3 months or 50 Hours	12 months or 100 hours
Inspect / top up oil levels Engine Gearbox Pump	*		
Change Oil Gearbox (EP90 Gear Oil) Pump (SAE30 Pump Oil) (Change engine oil in-line with the engine manufacturers recommendation), or at -		* * First 3 months or 50hrs only)	* * *
Clean water inlet filter	*		
Inspect and or change, engine/gearbox drive key Inspect Change (It is recommended that you consult your dealer before performing this item of maintenance)			* * (if required)
Inspect high-pressure hose and its connection for tightness and damage	*		
Inspect suction hose and its connections for tightness and damage	*		
High pressure jet Inspect Change	*		*
Pneumatic tyres Check/Inflate tyre pressures (0.7bar, 10psi)	*		

8. Storage

- Disconnect pressure hose and lance, draining water from the hose.
- Disconnect water feed hose, draining water from the hose.
- Wash out detergent hose with clean water, draining water from the hose.
- Turn over the engine by hand to expel water from pump.
- Ensure the equipment is clean and dry before storage.
- The equipment should be stored in a **dry and frost** proof place.

9.

Fault Finding

Symptom	Possible Cause	Remedy
Pump running normally but pressure low. Nozzle badly worn	Lance in low pressure mode Pressure Regulator valve Pump sucking air. Worn piston packing	Check and adjust Check and adjust Check water supply and possible air ingress. Check and/or replace Seek professional advice
Fluctuating pressure	Blocked water filter Pump sucking air	Check filter, clean or replace if necessary. Check integrity of suction hose and connections.
Pressure low after a long period of normal use.	Nozzle badly worn	Check and/or replace
Pump noisy.	Pump sucking air Excessive temperature of liquid in pump Worn bearing or valves	Check integrity of suction hose and connections. Reduce temperature to below 60°C, do not allow pump to idle for long periods. Seek professional advice
Presence of water in oil.	Ingress through breathers Worn oil seals	Replace oil, do not wash engine or pump Seek professional advice
Water dripping from under pump.	Worn piston packing	Seek professional advice
Oil dripping from pump/gearbox/engine.	Worn oil seal	Seek professional advice
Excessive vibration in lance/delivery line.	Water supply low Ingress of air into suction line Irregular functioning of valves	Check adequacy of water supply. Ensure suction filter is below water level. Check integrity of suction hose and connections. Seek professional advice

10. Warranty

Limited Warranty Supplied by Dual Pumps Ltd

Dual Pumps Ltd as suppliers warrants to the original purchaser, each new unit or other product supplied from its factory, for the period of twelve (12) months from the date of shipment from the factory, six (6) months for equipment on hire or rental), to be free from defects in material and workmanship under normal use and service. "Normal Use and Service" means not to exceed recommendations on maximum speeds, pressures and temperatures or handling fluids not compatible materials, as noted in the applicable Dual Pumps catalogue, technical literature and instructions. This warranty shall not apply to any pump or other product, which has been repaired or altered, to adversely affect the performance or reliability of the pump or product. Lance or hoses are not covered by this warranty due to the adverse conditions of their use.

Neither this warranty nor any implied warranty apply to damage caused by any of the following:

1. Freight damage
2. Frost or freezing damage
3. Damage caused by parts and/or accessories or components not obtained from or approved by Dual Pumps Ltd.
4. Any consequential or incidental damage arising from the use of any, pump or other products supplied by Dual Pumps Ltd.
5. Damage due to misapplication and/or misuse. The normal wear of moving parts or components affected by moving parts.

The liability of Dual Pumps Ltd under the foregoing warranty is limited to the repair or replacement at Dual Pumps Ltd option without charge for labour, mileage costs or materials of any parts upon return of the entire pump or other product or of the particular part to the Dual Pumps Ltd factory within the warranty period at the sole expense of the purchaser, which part shall upon examination appear to Dual Pumps Ltd satisfaction to have been defective in material or workmanship.

The liability of Dual Pumps Ltd under any theory or recovery (except any express warranty where the remedy is set forth in the above paragraph) for loss, harm or damage, shall be limited to the lesser of the actual cost, harm or damage, or the purchase price of the involved pump or other product when sold by Dual Pumps Ltd to its customer. Dual Pumps Ltd expressly warrants its pumps or other products as above stated.

There are no other express warranties. Any implied warranties, including implied warranty of merchantability or of fitness for a particular purpose, are limited in duration to twelve (12) months from the date of the purchase by the original

purchaser, (six (6) months for the equipment on hire or rental). There is no implied warranty of fitness for a particular purpose or merchantability when this product is put to rental use.

No person including any dealer or representative of Dual Pumps Ltd is authorised to make any representation or warranty concerning Dual Pumps Ltd products on behalf of Dual Pumps Ltd, or to assume for Dual Pumps Ltd the obligations contained in this warranty. Dual Pumps Ltd reserves the right to make changes in design and other changes and improvements upon its products without imposing any obligation on itself to install the same, in its existing products or products then in process or manufacture.

This warranty does not affect any statutory rights that you may have.

Procedure for claiming under this warranty

The claimant must despatch the unit, product or part at his own expense to the Dual Pumps Ltd factory with a full detailed report for inspection, upon receipt Dual Pumps Ltd will inspect and decide whether the unit, product or part is in fact a genuine warranty claim. Upon this decision the pump, product or part will be replaced either free of charge under this warranty or despatched and charged to the original customer together with a full report should it be found not to be covered by this warranty.

Warranty claimed items, if required urgently will be despatched to the customer and charged for, on receipt of the claimed defective item Dual Pumps Ltd will decide whether the claim is valid and if so will issue a credit for the item. Should Dual Pumps Ltd find the claimed item to be out of warranty declarations the said charge will stand and be paid by the customer as normal.

The copyright of this manual belongs to Dual Pumps Ltd and must not be copied or reproduced without the express permission of the company.

Appendix 1. Lance variations

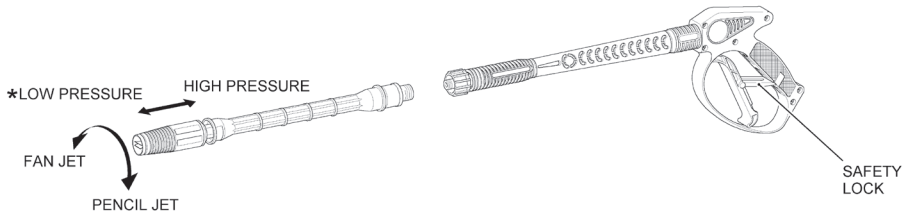

MULTIREG NOZZLE WITH SPLIT LANCE ASSEMBLY

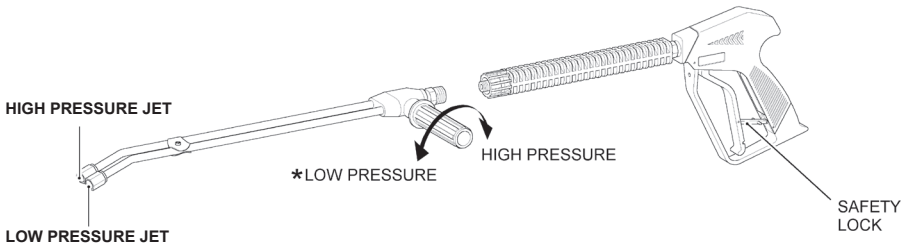

SPLITABLE TWIN LANCE ASSEMBLY

***NOTE**

LOW PRESSURE FOR
CHEMICAL INDUCTION

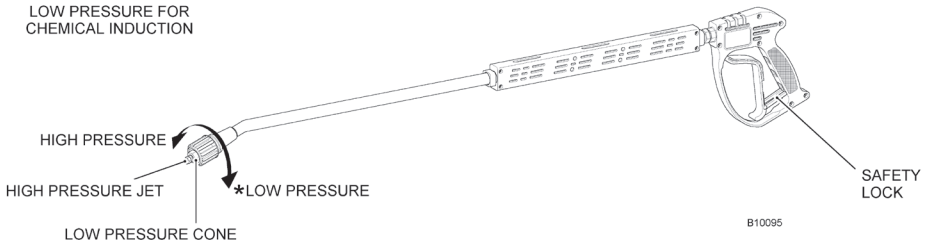

FIXED SINGLE LANCE WITH ADJUSTABLE NOZZLE



Unit 8, Hudson Road
Saxby Road Ind. Est.
Melton Mowbray
Leicestershire LE13 1BS

Telephone: +44 (0)1664 567226 Fax: +44 (0)1664 410127
E-mail: info@dualpumps.co.uk www.dualpumps.co.uk